

alberta[®]
Made in Italy



BOOK 01-02
4th Edition



BLACK collection

Black è eleganza, fascino, forza.

Alberta sceglie un simbolo di raffinatezza e stile indiscusso per rappresentare la forza della sua nuova collezione. Linee geometriche e volumi accoglienti diventano un segno distintivo dell'azienda, sempre pronta a rinnovarsi per interpretare al meglio lo stile dell'abitazione contemporanea. Tessuti, finiture, colori sono selezionati ed accostati con cura e sapienza sartoriale, per creare prodotti unici ed esclusivi, capaci di "disegnare" lo spazio in cui sono inseriti con personalità ed un pizzico di ironia.



Black is elegance, fascination, strength.

Alberta chooses a symbol of undisputed sophistication and style to express the strength of the new collection. The geometric lines and enveloping shapes become a trademark for the company, always ready to innovate to better express modern living styles. Fabrics, finishes, colours are all carefully and expertly selected and matched to create unique, exclusive products that "design" the interiors with all their personality and a touch of irony.



Black c'est l'élégance, le charme, la force.

Alberta choisit un symbole de raffinement et de style incontesté pour représenter la force de sa nouvelle collection. Les lignes géométriques et les volumes accueillants deviennent un signe distinctif de l'entreprise, toujours prête à se renouveler pour interpréter au mieux le style de l'habitat contemporain. Les tissus, les finitions et les couleurs sont sélectionnés et associés avec soin et un savoir-faire artisanal, pour créer des produits uniques et exclusifs, en mesure de « dessiner » l'espace dans lequel ils sont intégrés avec personnalité et une pincée d'ironie.



Black ist Eleganz, Charme, Stärke.

Alberta entscheidet sich für ein Symbol der Eleganz und für unbestrittenen Stil, um die Stärke der neuen Kollektion zu zeigen. Die geometrischen Linien und behaglichen Formen werden so zu einem Erkennungszeichen der Firma, die jederzeit bereit ist, neue Wege einzuschlagen und den Stil modernen Wohnens gekonnt zu interpretieren. Stoffe, Oberflächen und Farben werden mit großer Sorgfalt und Schneiderkunst ausgewählt und für einzigartige und exklusive Möbel kombiniert. Möbel, die in der Lage sind, den Raum, in dem sie stehen, mit Persönlichkeit und einem kleinen Augenzwinkern zu "designen".

alberta

INDICE • INDEX

DIVANI • SOFAS.....	8
RIEPILOGO • SUMMARY.....	83
FINITURE • FINISHING.....	91
DATI TECNICI • TECHNICAL DATA.....	97

DIVANI • SOFAS



LAGUNA.....8



DION.....36



BOWIE.....62

POLTRONE • ARMCHAIRS



JAMMIN.....35, 48, 49, 50, 52, 53, 71



JAMMIN LARGE.....51, 52, 53

POLTRONE • ARMCHAIRS



GOSSIP.....78, 79, 80, 81



SWEET JANE.....17, 18, 20, 21



CECILE.....10, 14, 25

TAVOLINI • SMALL TABLES



ISLAND 24, 25, 26, 27, 34, 35



PHIL 17, 21, 23, 39, 40, 42, 55, 57, 58, 59, 60, 63, 65



JIMMY 3 9, 10, 11



FRISCO 16, 17, 18, 20, 21, 35, 43, 47, 56, 63, 64, 68, 69, 70, 71, 72, 73, 75, 76, 77, 81



JAGGER 10, 14, 15, 35, 37, 40, 48, 51, 60, 63, 74



ALBERT 1 10, 11, 12, 13, 25, 27, 50

LAGUNA



IT • Tratti distintivi del sistema di sedute Laguna sono le linee semplici e i volumi morbidi. Gli ampi cuscini e l'accogliente seduta invitano al relax esprimendosi in un design contemporaneo.

La vasta gamma di elementi, declinati in due diverse profondità, permette un'ampia modularità e consente combinazioni infinite, arredando così qualsiasi tipo di ambiente, da quelli più ampi a quelli di piccole dimensioni.

EN • The stand-out features of Laguna seating are the simple lines and soft shapes. The large cushions and roomy seat are an invitation to relax with a contemporary design.

The wide variety of elements, available in two different depths, results in a very modular design which can be combined in an endless ways. The sofa is ideal for furnishing any setting, from the biggest to the smallest.

FR • Les traits distinctifs du système d'assise Laguna sont les lignes et les volumes souples. Les amples coussins et l'accueillante assise invitent au relax, le tout exprimé en un design contemporain.

La vaste gamme d'éléments, divisée en deux différentes profondeurs, permet une ample modularité et de nombreuses combinaisons, pour meubler toutes les types de pièces, grandes ou petites.

D • Die besonderen Kennzeichen des Sitzsystems Laguna sind die klaren Linien und die weichen Volumen. Die großen Kissen und die umhüllende Sitzfläche laden zum Entspannen ein und bestechen durch ein modernes Design.

Die große Auswahl an Elementen, die in zwei verschiedenen Tiefen erhältlich sind, sorgt für besondere Modularität und ermöglicht unzählige Kombinationen. So kann jede Art von Raum eingerichtet werden – von den größten Räumen bis hin zu Räumen mit kleinen Maßen.

Design by
Castello Lagravinese Studio





















LAGUNA composizione/composition/Komposition cm 401x98/152
1LAGTRSP + 1LAGD3DX • 7636 Dolm Col.42, Cat. 7 - Grosgrain G41





LAGUNA divano/sofa/canapé/Sofa cm 260x98
1LAGD3 • 7636 Dolm Col.42, Cat. 7 - Grosgrain G41





DION



IT • Il sistema modulare Dion è la massima espressione della personalizzazione di un divano. Oltre all'infinita componibilità, per arredare qualsiasi tipo di spazio, è infatti possibile scegliere tra due diverse profondità di seduta e due diverse altezze di schienale per soddisfare le esigenze e i desideri di ogni utilizzatore. Completano la gamma penisole dalle forme accattivanti, autentico invito al relax.

EN • If you are looking for a highly customizable sofa, Dion modular system is the perfect solution. In addition to its many possible configurations suitable to furnish any kind of space, two different seat depths as well as two different backrest heights are available to perfectly meet the needs and tastes of all users. The range is completed by charming islands, a true invitation to relax.

FR • Le système modulaire Dion est l'expression maximale de la personnalisation d'un canapé. En plus de la composition infinie, permettant d'aménager tout type d'espace, il est en effet possible de choisir entre deux profondeurs d'assise différentes et deux hauteurs de dossier différentes pour satisfaire les besoins et les désirs de chaque utilisateur. Des îles aux formes ensorceleuses complètent la gamme et sont une véritable invitation à la détente.

D • Die kombinierbare Polstergarnitur Dion verleiht der Personalisierung eines Sofas eine ganz neue Bedeutung. Es gibt nicht nur unzählige Kombinationsmöglichkeiten, mit denen sich Räume aller Art einrichten lassen, sondern es kann auch zwischen zwei verschiedenen Sitztiefen und zwei Höhen der Rückenlehne gewählt werden, um auch anspruchsvollsten Kunden gerecht zu werden. Ergänzt wird die Serie mit Recamieren mit ansprechender Form, die zum Entspannen einladen.

Design by
Castello Lagravinese Studio

BLACK
collection









DION divano/sofa/canapé/Sofa cm 265x116
2DNIEFAP • 9C7 Sensation Camel, Cat.H













PHIL tavolino/small table/table/Couchtisch
1PHISER • marmo/marble/marbre/Marmor Calacatta white, Cat. X4
• struttura/structure/structure/Struktur French Bronze
PHIL tavolino/small table/table/Couchtisch
1PHISER • marmo/marble/marbre/Marmor Marquina Black, Cat. X2
• struttura/structure/structure/Struktur Gun Metal









BOWIE



IT • Forme lineari e comfort avvolgente contraddistinguono l'estetica del sistema di sedute Bowie, caratterizzato dalla leggerezza del disegno dei braccioli e dei piedini in metallo. Gli ampi cuscini di schienale conferiscono a questo modello una linea pulita associata ad un'accogliente intimità. Un divano disegnato per chi ama forme eleganti con particolare attenzione al comfort.

EN • Linear forms and enveloping comfort distinguish the esthetics of the Bowie seating system, characterized by the lightness of the design of the armrests and metal feet. The ample cushions of the backrest give this model a clean line associated with a comfortable intimacy. A sofa designed for those who love elegant forms, with particular attention to comfort.

FR • Des formes épurées au confort enveloppant définissent l'esthétique du système Bowie, caractérisé par la légèreté du design des accoudoirs et des pieds en métal. Les amples coussins du dossier font ressortir la pureté de la ligne tout en évoquant une atmosphère d'intimité chaleureuse. Un canapé conçu pour ceux qui estiment les formes élégantes et qui recherchent le confort.

D • Lineare Formen und einzigartiger Komfort bestimmen die Ästhetik des Sitzsystems Bowie, das sich durch die Leichtigkeit der Konstruktion der Arme und Beine aus Metall kennzeichnet. Die großen Rückenkissen verleihen diesem Modell klare Linien, die mit einer kuscheligen Intimität verbunden sind. Dieses Sofa richtet sich an diejenigen, die elegante Formen mit einer besonderen Aufmerksamkeit auf Komfort lieben.

Design by
Castello Lagravinese Studio

BLACK
collection





BOWIE divano/sofa/canapé/Sofa cm 260x106
2BOW230 • 942 Fjord Dark Brown, Cat.G
• piede/foot/pied/fuß Gun Metal











FRISCO 120 • FRISCO 75 • FRISCO 50 tavolino/small table/table/Couchtisch
• Top 1 marmo/marble/marbre/Marmor Calacatta White, Cat. X4
• Top 2 Green • struttura/structure/Struktur French Bronze







RIEPILOGO • SUMMARY



LAGUNA



10

11

- LAGUNA** divano/sofa/canapé/Sofa
 • 01LAGC19 (1LAGD3SX + 1LAGMERSDX) • 6524 Romuald Creta, Cat. 6 • Grosgrain G54
CECILE poltrona/armchair/fauteuil/Sessel
 • 2CECPW • 942 Fjord Dark brown, Cat. G • Struttura/structure/Struktur Dark Oak, Gun Metal
ALBERT 1 130x80 tavolino/small table/table/Couchtisch 130x80
 • 1AL1TAVR • Top marmo/marble/marbre/Marmor Marquina black, Cat. X2 • struttura/structure/Struktur Dark Oak
JIMMY 3 160x40 consolle/console/Konsole
 • 1JI3CO160 • Top Mink brown • struttura/structure/Struktur Gun Metal
JIMMY 3 tavolino/small table/table/Couchtisch
 • 1JI3SER • Top Mink Brown • struttura/structure/Struktur Gun Metal
JAGGER tavolino/small table/table/Couchtisch ø50
 • 1JAGTL • Mink Brown

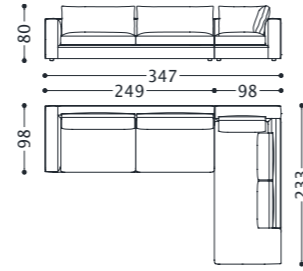

24

25

- LAGUNA** divano/sofa/canapé/Sofa
 • 01LAGC17 (1LAGTRSPC+ 1LAGD3DX) • 8261 Day oasis, Cat. 8 • Grosgrain G44
CECILE poltrona/armchair/fauteuil/Sessel
 • 2CECPNC • 9C9 Sensation Nut, Cat. H • Struttura/structure/Struktur Noce Canaletto, French Bronze
JAGGER 75 tavolino/small table/table/Couchtisch ø75
 • 1JAGTM • Mink Brown
JAGGER 35 tavolino/small table/table/Couchtisch ø35
 • 1JAGTH • Dove Grey
ALBERT1 50 tavolino/small table/table/Couchtisch ø50
 • 1AL1TROT50 • Top marmo/marble/marbre/Marmor Calacatta White, Cat. X4 • struttura/structure/Struktur Noce Canaletto
ISLAND tavolino/small table/table/Couchtisch
 • 1ISNTLTS30 • 1ISNTMTS23 • 1ISNTSTS40 • Top Noce Canaletto • struttura/structure/Struktur French Bronze

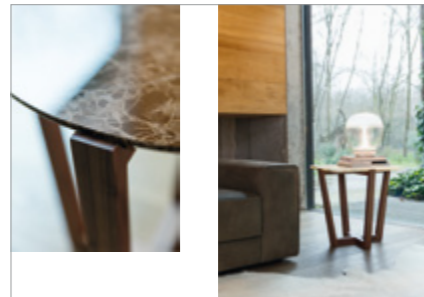
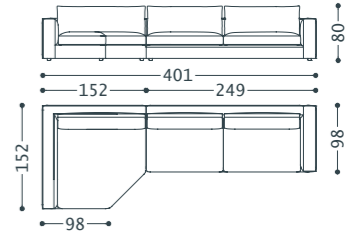

12

13

- ALBERT 1** tavolino/small table/table/Couchtisch 75x75
 • 1AL1TAVQ75 • Top marmo/marble/marbre/Marmor Arabesue Purple, Cat. X1 • struttura/structure/Struktur Noce Canaletto



34

35

- LAGUNA** divano/sofa/canapé/Sofa
 • 1LAGD3MPR • 6046 Balboa salepepe, Cat. 6 - Grosgrain G41
JAMMIN poltrona/armchair/fauteuil/Sessel
 • 8196 Zincy Grigio chiaro, Cat. 8 • basamento/base/piétement/Basis French Bronze
FRISCO 50 tavolino/small table/table/Couchtisch ø50
 • 1FRITROT • Top 1 marmo/marble/marbre/Marmor Calacatta White, Cat. X4 • Top 2 Dove Grey • struttura/structure/Struktur French Bronze
ISLAND tavolino/small table/table/Couchtisch
 • 1ISNTTLTS30 • Top Noce Canaletto • struttura/structure/Struktur French Bronze
ISLAND tavolino/small table/table/Couchtisch
 • 1ISNTSTS40 • Top Noce Canaletto • struttura/structure/Struktur French Bronze
JAGGER 75 tavolino/small table/table/Couchtisch ø75
 • 1JAGTM • Cream

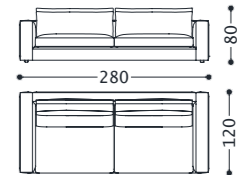

16

17

- LAGUNA** divano/sofa/canapé/Sofa
 • 1LAGD3PRSX + 1LAGPTPR + 1LAGPFFR (nr.2) + 1LAGD2M1 + 1LAGPT + 2LAGTRSP
 • 1LAGD3PRSX + 1LAGPTPR + 1LAGPFFR (nr.2) + 1LAGD2M1 + 1LAGPT • 7635 Dolm col.27, Cat. 7 • Grosgrain G53
 • 2LAGTRSP • 942 Fjord Dark Brown, Cat. G • Grosgrain G53
SWEET JANE poltrona/armchair/fauteuil/Sessel
 • 1SWJP • 7905 PDP small sabbia, Cat. 7 • gambe/legs/jambes/Beine French Bronze
 • 2SWJP • 5B070 Bob Testa di Moro, Cat. F • gambe/legs/jambes/Beine French Bronze
FRISCO 120X120 tavolino/small table/table/Couchtisch 120X120
 • 1FRITAVQB • Top 1 marmo/marble/marbre/Marmor Calacatta White, Cat. X4 • Top 2 Mink Brown • struttura/structure/Struktur French Bronze
PHIL tavolino/small table/table/Couchtisch
 • 1PHISER • marmo/marble/marbre/Marmor Verde Issorie, Cat. X4 • struttura/structure/Struktur Gun Metal

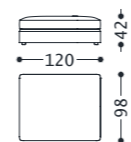
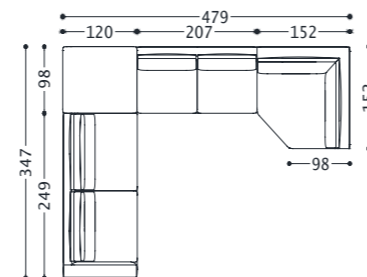

DION

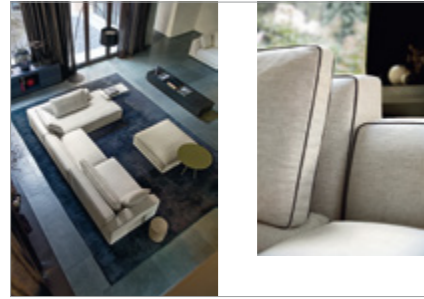

40

41

DION divano/sofa/canapé/Sofa
 • 01DNIC2 (1DNIECASXP - 1DNIECB1 - 1DNIEBDEXP) • 7340 Milano Lino, Cat. 7 • Grosgrain G41
 • 1DNIEQ • 6071 Teller Ghiaccio, Cat. 6
PHIL tavolino/small table/table/Couchtisch
 • 1PHISER • marmo/marble/marbre/Marmor Calacatta White, Cat. X4 • struttura/structure/structure/Struktur Gun Metal
JAGGER 75 tavolino/small table/table/Couchtisch ø75
 • 1JAGTM • Green

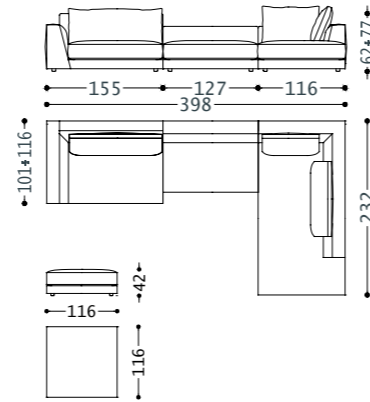

50

51

JAMMIN poltrona/armchair/fauteuil/Sessel
 • 1JAMP • 6046 Balboa Salepepe - 612E Eco Club Fango, Cat. 6
 • piede/foot/pied/Fuß Gun Metal
JAMMIN LARGE poltrona girevole/swivel armchair/fauteuil tournant/Drehstuhl
 • 2JAMPLG • 942 Fjord Dark Brown, Cat. G • basamento/base/piétement/Basis Gun Metal

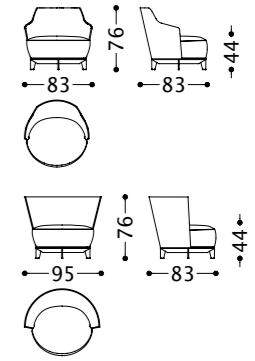

43

DION divano/sofa/canapé/Sofa
 • 2DNIEFAP • 9C7 Sensation Camel, cat.H
FRISCO 75 tavolino/small table/table/Couchtisch 75x75
 • 1FRITAVQA • Top 1 marmo/marble/marbre/Marmor Daino Reale, Cat. X2 • Top 2 Dove Grey • struttura/structure/structure/Struktur French Bronze

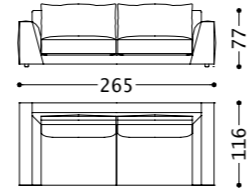

56

57

DION divano/sofa/canapé/Sofa
 • 01DNIC31 (1DNIEFASXP - 1DNIEUAP) • 6956 Sfalero Greige, Cat. 6
PHIL tavolino/small table/table/Couchtisch
 • 1PHISER • marmo/marble/marbre/Marmor Calacatta White, Cat. X4 • struttura/structure/structure/Struktur Gun Metal
FRISCO 50 tavolino/small table/table/Couchtisch ø50
 • 1FRITROTL • Top 1 Dove Grey • Top 2 Dove Grey • struttura/structure/structure/Struktur French Bronze

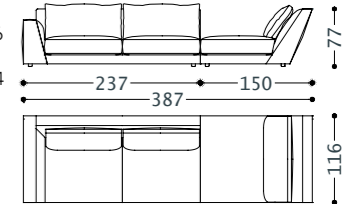

46

47

DION divano/sofa/canapé/Sofa
 • 01DNIC37 (1DNIEPASXP - 1DNIEFADXP)
FRISCO 75 tavolino/small table/table/Couchtisch 75x75
 • 1FRITAVQA • Top 1 marmo/marble/marbre/Marmor Magic Brown, Cat. X1 • Top 2 Dove Grey • struttura/structure/structure/Struktur Gun Metal

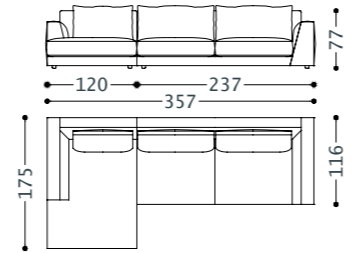

59

DION divano/sofa/canapé/Sofa
 • 1DNIEVA • 6956 Sfalero Greige, Cat. 6
PHIL tavolino/small table/table/Couchtisch
 • 1PHISERL • Bordeaux • struttura/structure/structure/Struktur French Bronze

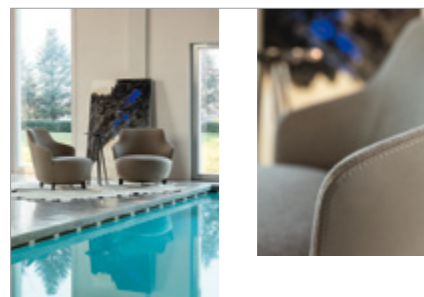
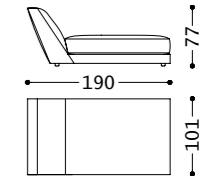

48

49

JAMMIN poltrona/armchair/fauteuil/Sessel
 • 1JAMP • 6956 Sfalero Greige, Cat. 6 • 612N Eco club Grigio Oliva, Cat. 6 • piede/foot/pied/Fuß Gun Metal
JAGGER 35 tavolino/small table/table/Couchtisch ø35
 • 1JAGTH • Mink Brown

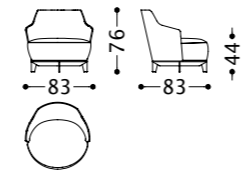

60

61

DION divano/sofa/canapé/Sofa
 • 01DNIC34 (1DNIEGASXP - 1DNIEXAP - 1DNIECA1P - 1DNIECA1P - 1DNIEOADXP) • 6139 Cavour platino, Cat. 6
JAGGER 35 tavolino/small table/table/Couchtisch ø35
 • 1JAGTH • Dove Grey
PHIL tavolino/small table/table/Couchtisch
 • 1PHISER • marmo/marble/marbre/Marmor Calacatta White, Cat. X4 • struttura/structure/structure/Struktur Gun Metal

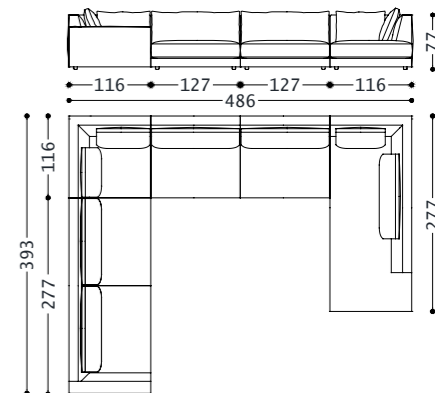

BOWIE



64

65

- BOWIE divano/sofa/canapé/Sofa**
 • 2BOW230 • 942 Fjord Dark Brown, Cat. G • piede/foot/pied/Fuß Gun Metal
BOWIE poltrona/armchair/fauteuil/Sessel
 • 2BOW310 • 942 Fjord Dark Brown, Cat. G • piede/foot/pied/Fuß Gun Metal
FRISCO 75 tavolino/small table/table/Couchtisch 75x75
 • 1FRITAVQA • Top 1 marmo/marble/marbre/Marmor Calacatta White, Cat. X4 • Top 2 Bordeaux • struttura/structure/structure/Struktur French Bronze
PHIL tavolino/small table/table/Couchtisch
 • 1PHISER • marmo/marble/marbre/Marmor Calacatta White, Cat. X4 • struttura/structure/structure/Struktur French Bronze

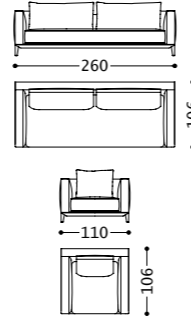

BOWIE



80

- GOSSIP poltrona/armchair/fauteuil/Sessel**
 • 1GSPP • 6047 Balboa Malachite, Cat. 6

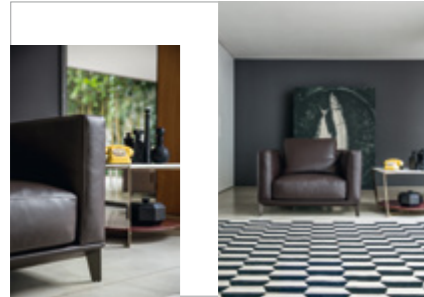
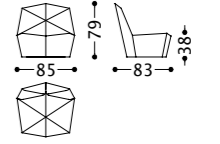

68

69

- BOWIE poltrona/armchair/fauteuil/Sessel**
 • 2BOW310 • 942 Fjord Dark Brown, Cat. G • piede/foot/pied/Fuß Gun Metal
FRISCO 75 tavolino/small table/table/Couchtisch 75x75
 • 1FRITAVQA • Top 1 marmo/marble/marbre/Marmor Calacatta White, Cat. X4 • Top 2 Bordeaux • struttura/structure/structure/Struktur French Bronze

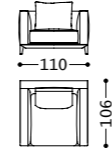

70

71

- BOWIE divano/sofa/canapé/Sofa**
 • 02BOWC15 (2BOW281SX-2BOW220DX) • 954 Fjord Sand, Cat.G • piede/foot/pied/Fuß Gun Metal
JAMMIN poltrona/armchair/fauteuil/Sessel
 • 1JAMP • 6133 Tara Smeraldo, Cat.6 • piede/foot/pied/Fuß Gun Metal
FRISCO 75 tavolino/small table/table/Couchtisch 75x75
 • 1FRITAVQA • Top 1 marmo/marble/marbre/Marmor Marquina Black, Cat. X2 • Top 2 Grey • struttura/structure/structure/Struktur Gun Metal
FRISCO 50 tavolino/small table/table/Couchtisch ø 50
 • 1FRITROT • Top 1 marmo/marble/marbre/Marmor Marquina Black, Cat. X2 • Top 2 Grey • struttura/structure/structure/Struktur Gun Metal

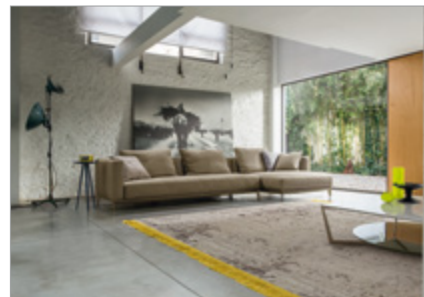
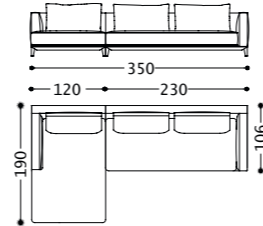

74

75

- BOWIE divano/sofa/canapé/Sofa**
 • 01BOWC6 (1BOW230SX-1BOW280DX) • 7152 Axinit Beige, Cat. 7 • piede/foot/pied/Fuß French Bronze
FRISCO 120 tavolino/small table/table/Couchtisch 120x120
 • 1FRITAVQB • Top 1 marmo/marble/marbre/Marmor Calacatta White, Cat. X4 • Top 2 Green • struttura/structure/structure/Struktur French Bronze
JAGGER 35 tavolino/small table/table/Couchtisch ø 35
 • 1JAGTH • Blue

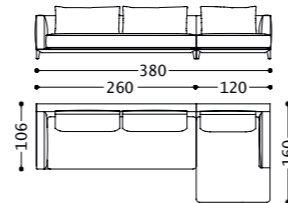

FINITURE • FINISHING



MARMO/MARBLE/MARBRE/MARMOR



Magic Brown • Cat. X1

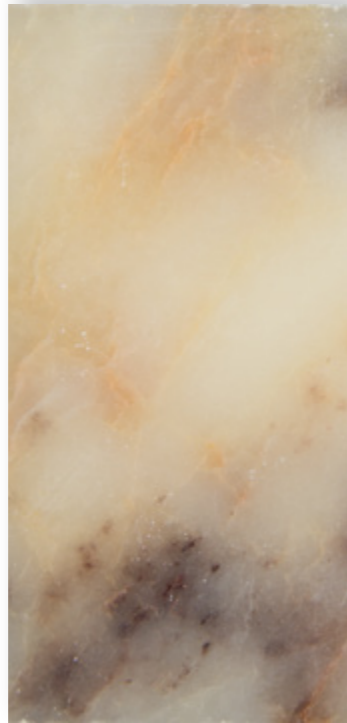

Arabesque purple • Cat. X1



Daino Reale • Cat. X2



Verde Issorie • Cat. X4

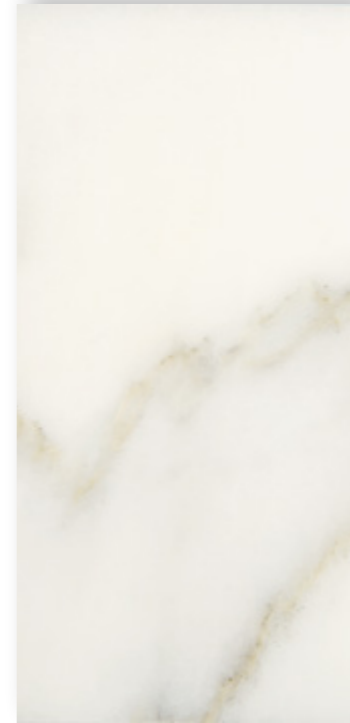

Calacatta White • Cat. X4



Cream Calacatta • Cat. X4



Marquina black • Cat. X2

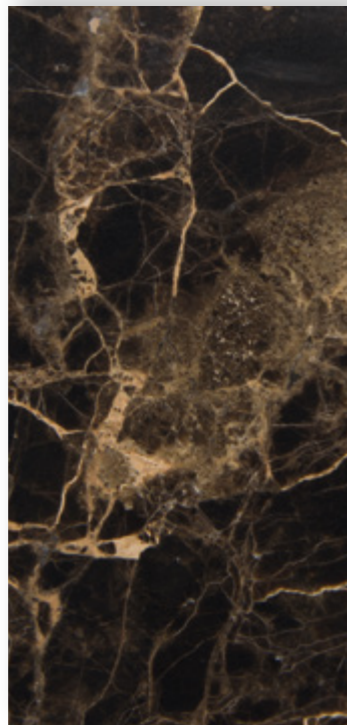

Emperador Brown • Cat. X3



Natural Travertino • Cat. X3

CERAMICA/CERAMIC/CÉRAMIQUE/KERAMIK



Calacatta White

METALLO/METAL/MÉTAL/METALL



Gun Metal

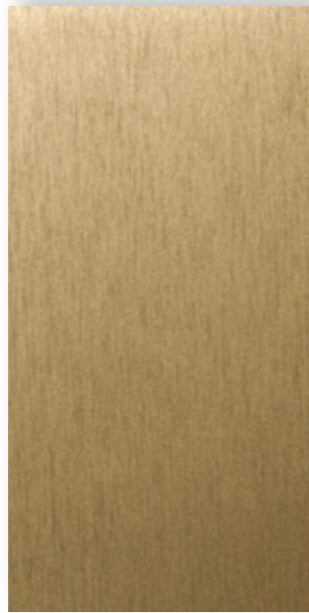

French Bronze



Glossy browned

LEGNO/WOOD/BOIS/HOLZ

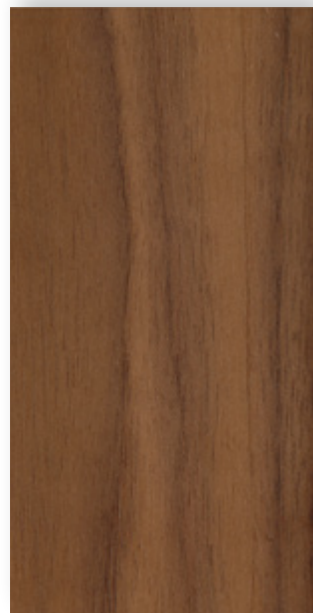

Noce Canaletto / Canaletto Walnut



Rovere Scuro / Dark Oak

LACCATI/LACQUERED/LAQUÉS/LACKIERT

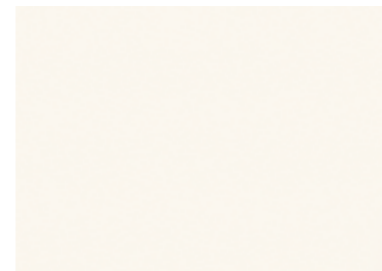

Ivory

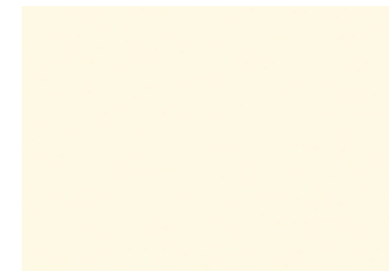

Cream

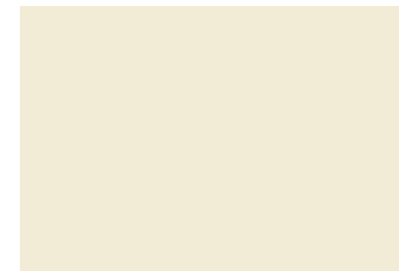

Snow



Mist



Grey



Dove Grey



Mink Brown

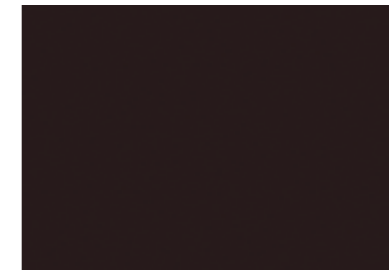

Dark brown



Green

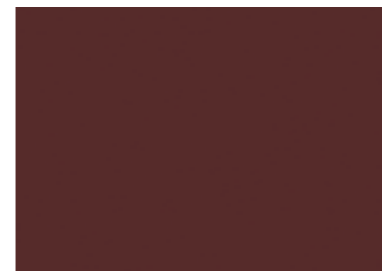

Bordeaux



Rust

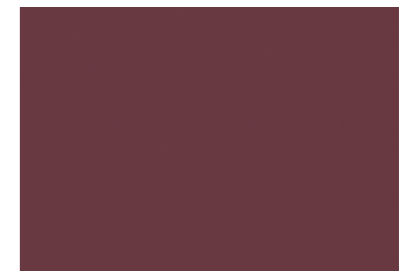

Burgundy



Blue

DATI TECNICI • TECHNICAL DATA

DIVANI • SOFAS

LAGUNA.....	98
DION	104
BOWIE.....	108

POLTRONE • ARMCHAIRS

GOSSIP.....	111
JAMMIN	112
JAMMIN LARGE.....	113
SWEET JANE	114
CECILE.....	115

TAVOLINI • SMALL TABLES

ISLAND.....	116
JIMMY 3.....	117
JAGGER.....	118
PHIL	119
FRISCO	120
ALBERT 1.....	121

LAGUNA divano/sofa/canapé/Sofa

elementi/elements/éléments/Elemente

Design by Castello Lagravinese Studio



Struttura portante: Multistrato, massello di legno.

Imbottiture: Cuscino di schienale in piuma d'oca e fibra di poliestere con inserto in poliuretano espanso (densità 21 kg/mc) rivestito in tela di cotone/poliestere. Secondo cuscino di schienale (elementi profondi) in piuma d'oca e fibra di poliestere rivestito in tela di cotone/poliestere. Cuscino di seduta in piuma d'oca e fibra di poliestere con inserto in poliuretano espanso a densità differenziata, rivestito in tela di cotone/poliestere. Scocca in poliuretano espanso a densità differenziata rivestita in resinato accoppiato a vellutino.

Molleggio: Cinghie elastiche in polipropilene e gomma.

Piedino: ABS.

Main structure: Multilayer and solid wood.

Upholstery: Backrest in goose feathers and polyester fiber with internal padding in polyurethane foam (density 21 kg/mc) covered with cotton fabric/polyester. Second backrest cushion (deep elements) in goose feathers and polyester fiber covered with cotton fabric/polyester. Seat cushion in goose feathers and polyester fiber with internal padding in polyurethane foam with different densities, covered with cotton fabric/polyester. Chassis in polyurethane foam with different densities covered with resinate coupled with elastic velvet.

Suspensions: Elastic belts in polypropylene and rubber.

Feet: ABS.

Structure: Multiplis, bois massif.

Rembourrage: Coussins de dossier en plumes d'oie et fibre de polyester avec insert en mousse de polyuréthane (densité 21 Kg/mc) sous housse de coton/polyester. Deuxième coussin de dossier (éléments profonds) en plumes d'oie et fibre de polyester sous housse de coton/polyester. Coussin d'assise en plumes d'oie et fibre de polyester avec insert en mousse de polyuréthane à densités différentes, sous housse de coton/polyester. Chassis en mousse de polyuréthane à densités différentes revêtue de résine accouplé avec velveteen.

Suspension: Sangles élastiques en polypropylène et mousse.

Pieds: ABS.

Hauptstruktur: vielschichtiges Massivholz.

Polsterung: Rückenissen aus Gänseedaunen und Polyesterfaser mit Einsatz aus Polyurethanschaum (Dichte 21 Kg/mc) mit Baumwolle-Polyesterstoffe bedeckt. Zweiter Rückenissen (tiefe Elemente) aus Gänseedaunen und Polyesterfaser mit Einsatz aus Polyurethanschaum in unterschiedlichen Dichten und mit Baumwolle-Polyesterstoffe bedeckt. Sitzkissen aus Gänseedaunen und Polyesterfaser mit Einsatz aus Polyurethanschaum in unterschiedlichen Dichten und mit Baumwolle-Polyesterstoffe bedeckt. Chassis aus Polyurethanschaum mit unterschiedlicher Dichte mit gekoppeltem Samt und Resinat verkleidet.

Federung: Elastische Gurte aus Gummi und Polypropylen.

Füße: ABS.

Cod. Tessuto/fabric/tissu/Stoff: 1/01

Cod. Pelle/leather/cuir/Leder: 2/02

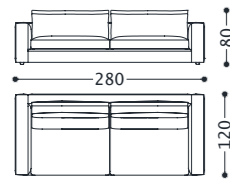
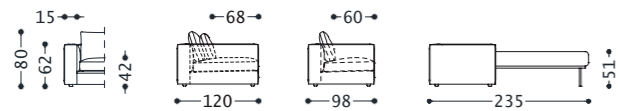

1LAGD3MPR
2LAGD3MPR

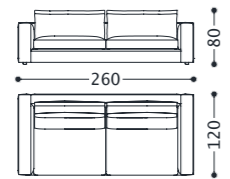

1LAGD3PR
2LAGD3PR

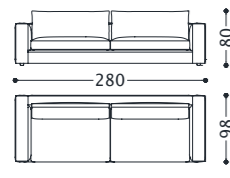

1LAGD3M
2LAGD3M

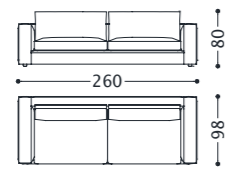

1LAGD3
2LAGD3

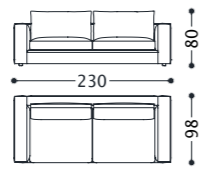

1LAGD2M
2LAGD2M

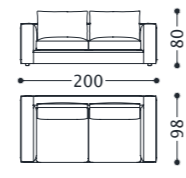

1LAGD2
2LAGD2

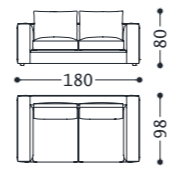

1LAGD2S
2LAGD2S

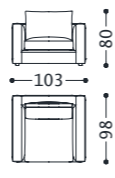

1LAGP
2LAGP

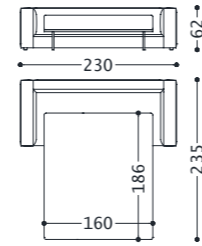

1LAGD2MSPP
2LAGD2MSPP

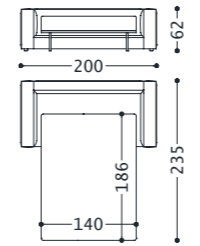

1LAGD2SPP
2LAGD2SPP

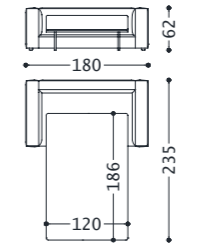

1LAGD2SSPP
2LAGD2SSPP

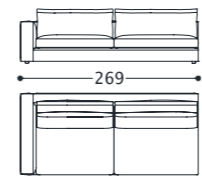

1LAGD3MPRSX
2LAGD3MPRSX

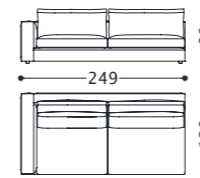

1LAGD3PRSX
2LAGD3PRSX

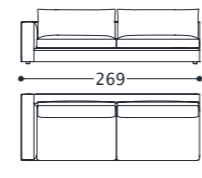

1LAGD3MSX
2LAGD3MSX

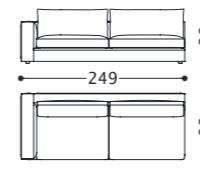

1LAGD3SX
2LAGD3SX

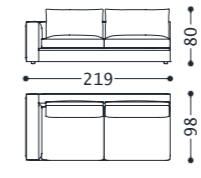

1LAGD2MSX
2LAGD2MSX

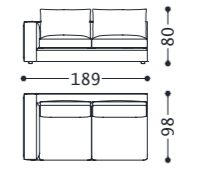

1LAGD2SX
2LAGD2SX

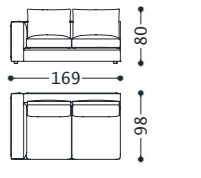

1LAGD2SSX
2LAGD2SSX

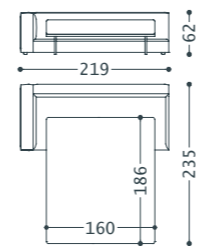

1LAGD2MSXSPP
2LAGD2MSXSPP

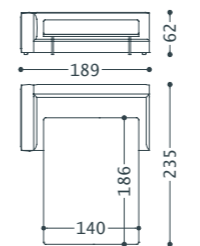

1LAGD2XSPP
1LAGD2XSPP

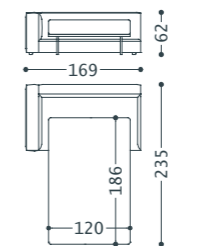

1LAGD2SSXSPP
2LAGD2SSXSPP

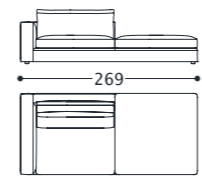

1LAGTR3MPRSX
2LAGTR3MPRSX

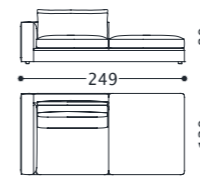

1LAGTR3PRSX
2LAGTR3PRSX

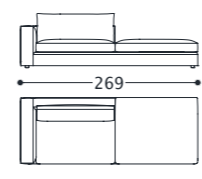

1LAGTR3MSX
2LAGTR3MSX

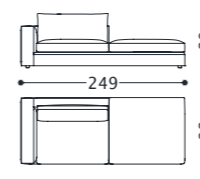

1LAGTR3SX
2LAGTR3SX

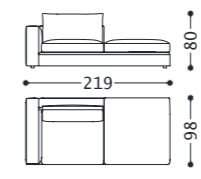

1LAGTR2MSX
2LAGTR2MSX

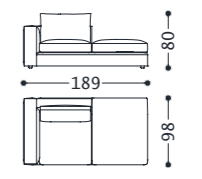

1LAGTR2SX
2LAGTR2SX

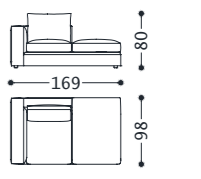

1LAGTR2SSX
2LAGTR2SSX



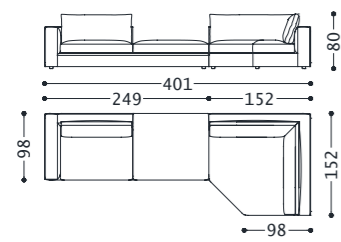

01LAGC1
 (1LAGTR3SX + 1LAGTRSP)
 02LAGC1
 (2LAGTR3SX + 2LAGTRSP)

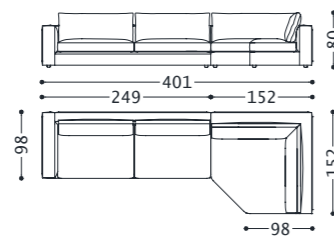

01LAGC10
 (1LAGD3SX + 1LAGTRSP)
 02LAGC10
 (2LAGD3SX + 2LAGTRSP)

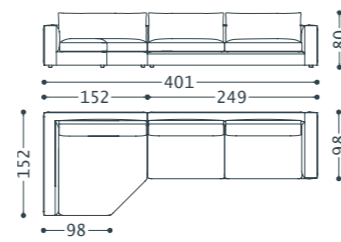

01LAGC17
 (1LAGTRSPSC + 1LAGD3DX)
 02LAGC17
 (2LAGTRSPSC + 2LAGD3DX)

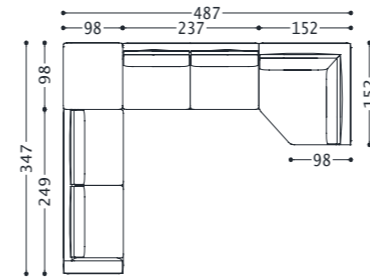

01LAGC11
 (1LAGD3SX + 1LAGPFFQ + 1LAGD31 + 1LAGTRSP)
 02LAGC11
 (2LAGD3SX + 2LAGPFFQ + 2LAGD31 + 2LAGTRSP)

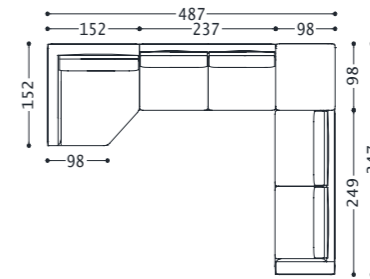

01LAGC18
 (1LAGTRSPSC + 1LAGD31 + 1LAGPFFQ + 1LAGD3DX)
 02LAGC18
 (2LAGTRSPSC + 2LAGD31 + 2LAGPFFQ + 2LAGD3DX)

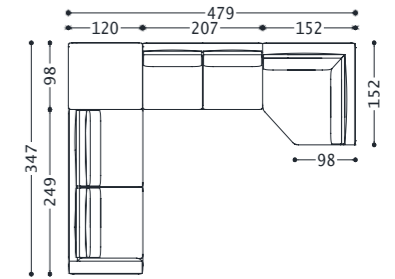

01LAGC14
 (1LAGD3PRX + 1LAGPFFR + 1LAGD2M1 + 1LAGTRSP)
 02LAGC14
 (2LAGD3PRX + 2LAGPFFR + 2LAGD2M1 + 1LAGTRSP)

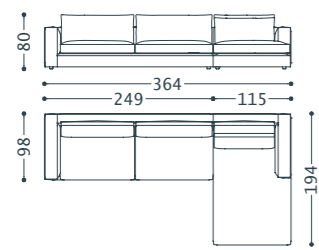

01LAGC2
 (1LAGD3SX + 1LAGCHLMDX)
 02LAGC2
 (2LAGD3SX + 2LAGCHLMDX)

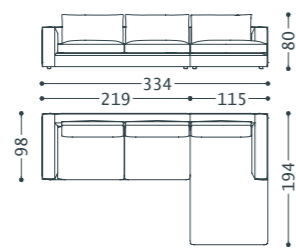

01LAGC8
 (1LAGD2MSX + 1LAGCHLMDX)
 02LAGC8
 (2LAGD2MSX + 2LAGCHLMDX)

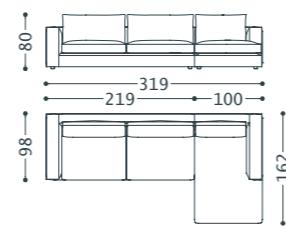

01LAGC4
 (1LAGD2MSX + 1LAGCHLDX)
 02LAGC4
 (2LAGD2MSX + 2LAGCHLDX)

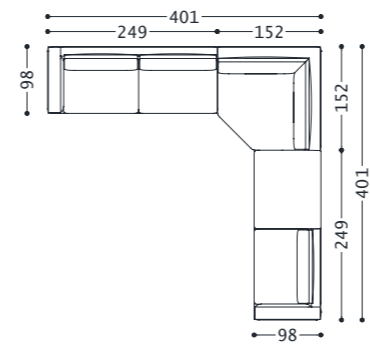

01LAGC6
 (1LAGD3SX + 1LAGTRSP + 1LAGTR3DX)
 02LAGC6
 (2LAGD3SX + 2LAGTRSP + 2LAGTR3DX)

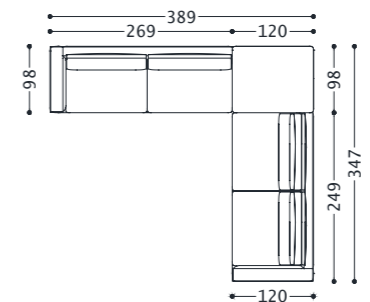

01LAGC5
 (1LAGD3MSX + 1LAGPFFR + 1LAGD3PRDX)
 02LAGC5
 (2LAGD3MSX + 2LAGPFFR + 2LAGD3PRDX)

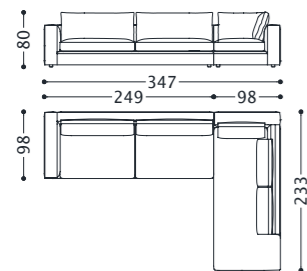

01LAGC19
 (1LAGD3SX + 1LAGMERSDX)
 02LAGC19
 (2LAGD3SX + 2LAGMERSDX)

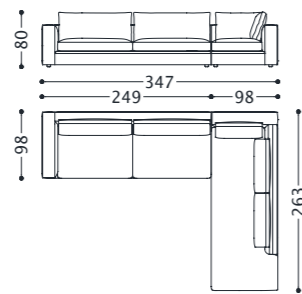

01LAGC3
 (1LAGD3SX + 1LAGMERDX)
 02LAGC3
 (2LAGD3SX + 2LAGMERDX)

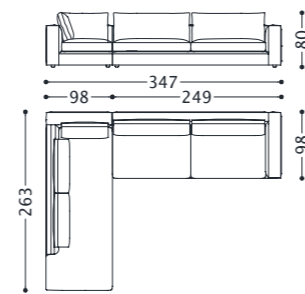

01LAGC9
 (1LAGMERSX + 1LAGD3DX)
 02LAGC9
 (2LAGMERSX + 2LAGD3DX)

DION divano/sofa/canapé/sofa
 elementi/elements/éléments/elemente

Design by Castello Lagravinese Studio



Struttura portante: multistrato, massello di legno.
Imbottiture: schienale in piuma d'oca, rivestito in tela di cotone. Cuscino di seduta in poliuretano espanso a densità differenziata, con imbottitura in piuma d'oca e rivestimento in tela di cotone. Scocca in poliuretano espanso a densità differenziata rivestito in falda termolegata accoppiata a cotone.
Molle: cinghie elastiche in polipropilene e gomma.
Piedini: ABS.

Main structure: multilayer and solid wood.
Upholstery: backrest in goose feathers, covered with cotton fabric. Seat cushion in polyurethane foam with different densities with goose feathers and covered with cotton fabric. Chassis in polyurethane foam with different densities covered with heat-bonded layer coupled with cotton.
Suspensions: elastic belts in polypropylene and rubber.
Feet: ABS.

Structure: multiplis et bois massif.
Rembouillage: dossier en plume d'oie sous housse de coton. Coussin d'assise en mousse de polyuréthane en plusieurs densités avec rembourrage en plume d'oie, sous housse de coton. Chassis en mousse de polyuréthane en plusieurs densités revêtu en fibre thermoliée accouplé avec coton.
Suspension: sangles élastiques en polypropylène et mousse.
Pieds: ABS.

Struktur: vielschichtiges Massivholz.
Polsterung: Rückenlehne aus Gänsedaunen mit Bezug in Baumwolle. Sitz aus Polyurethanschäum in unterschiedlichen Dichten mit Polsterung aus Gänsedaunen mit Bezug in Baumwolle. Chassis aus Polyurethanschäum in unterschiedlichen Dichten mit heiss geklebter Abdeckung die mit Baumwolle gekoppelt ist.
Federung: elastische Gurte aus Gummi und Polypropylen.
Füße: ABS.

Cod. tessuto/fabric/tissu/Stoff: 1/01
 Cod. pelle/leather/cuir/Leder: 2/02

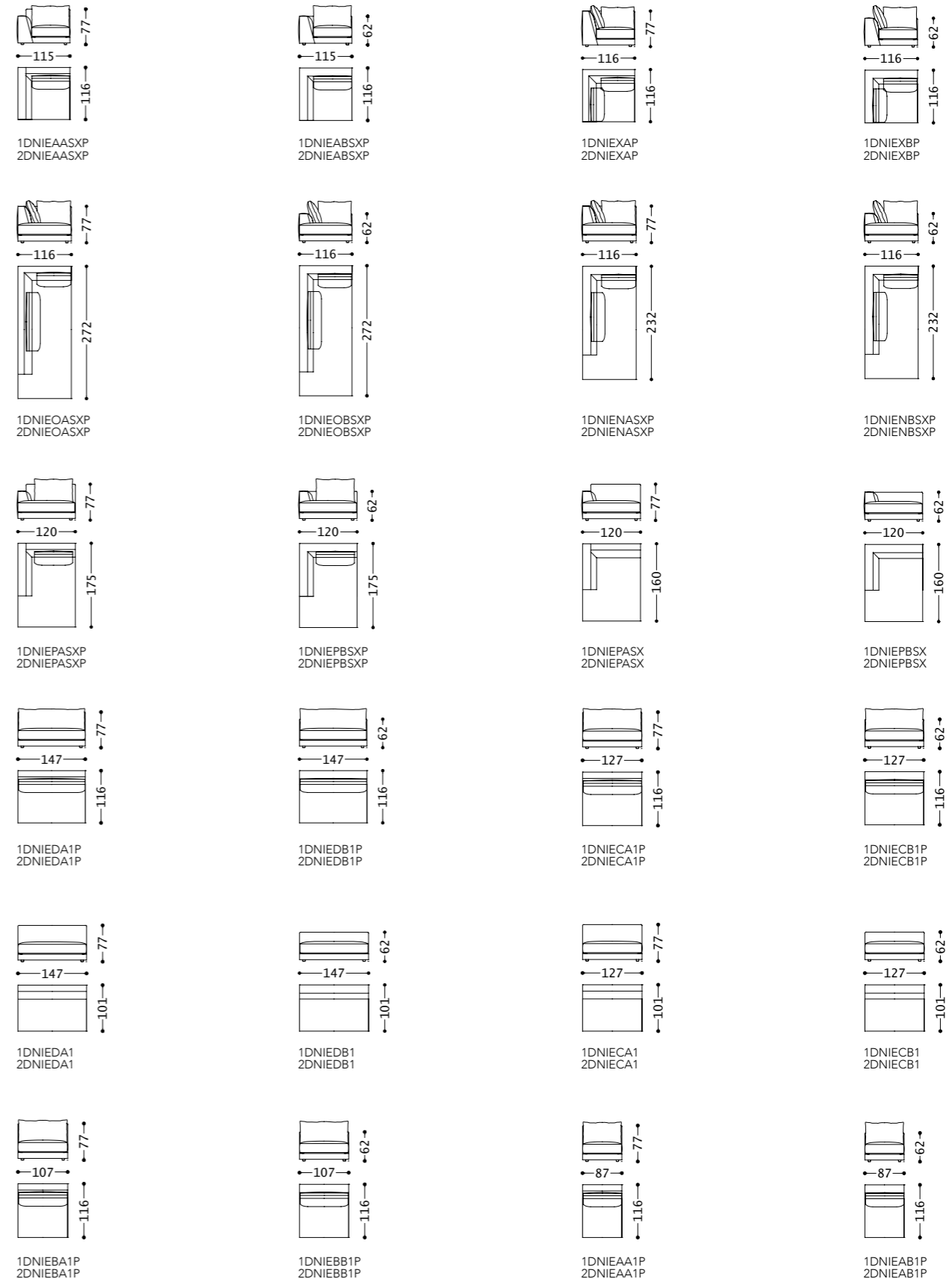
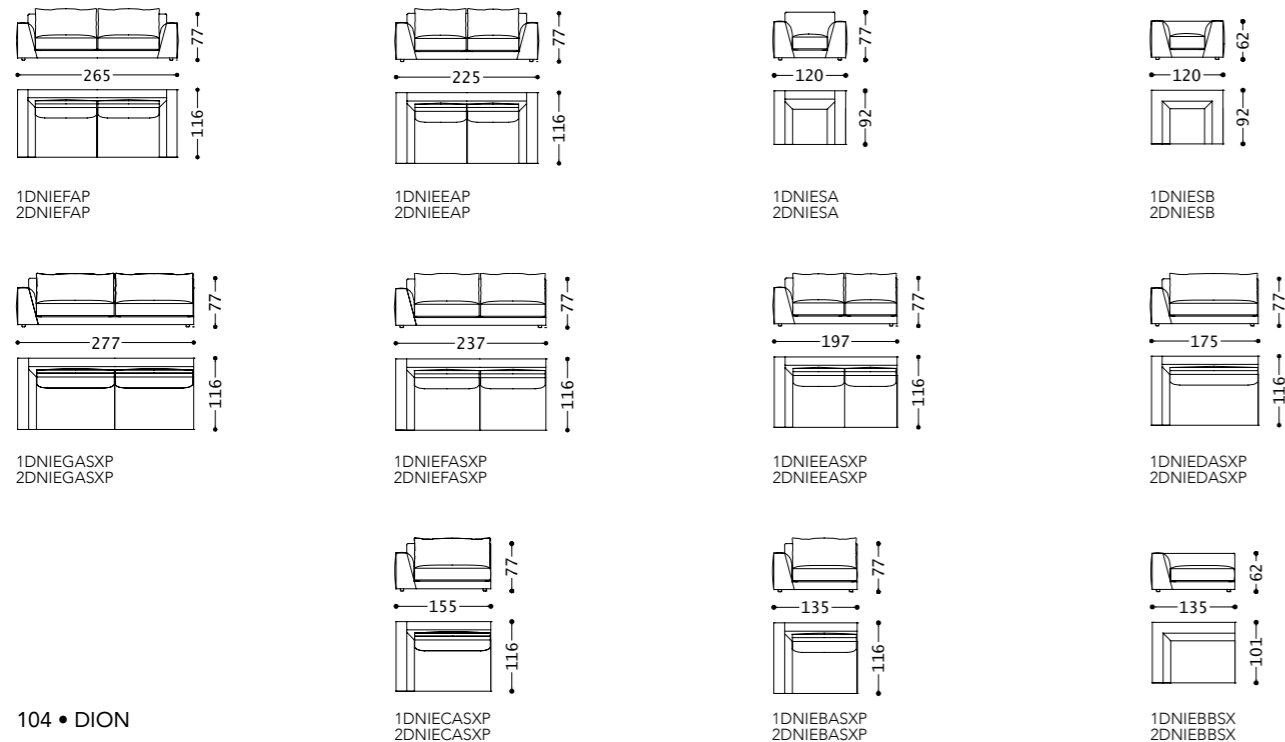
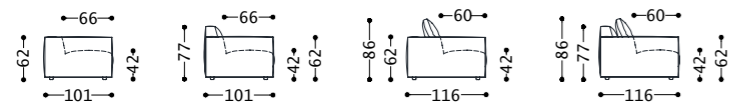

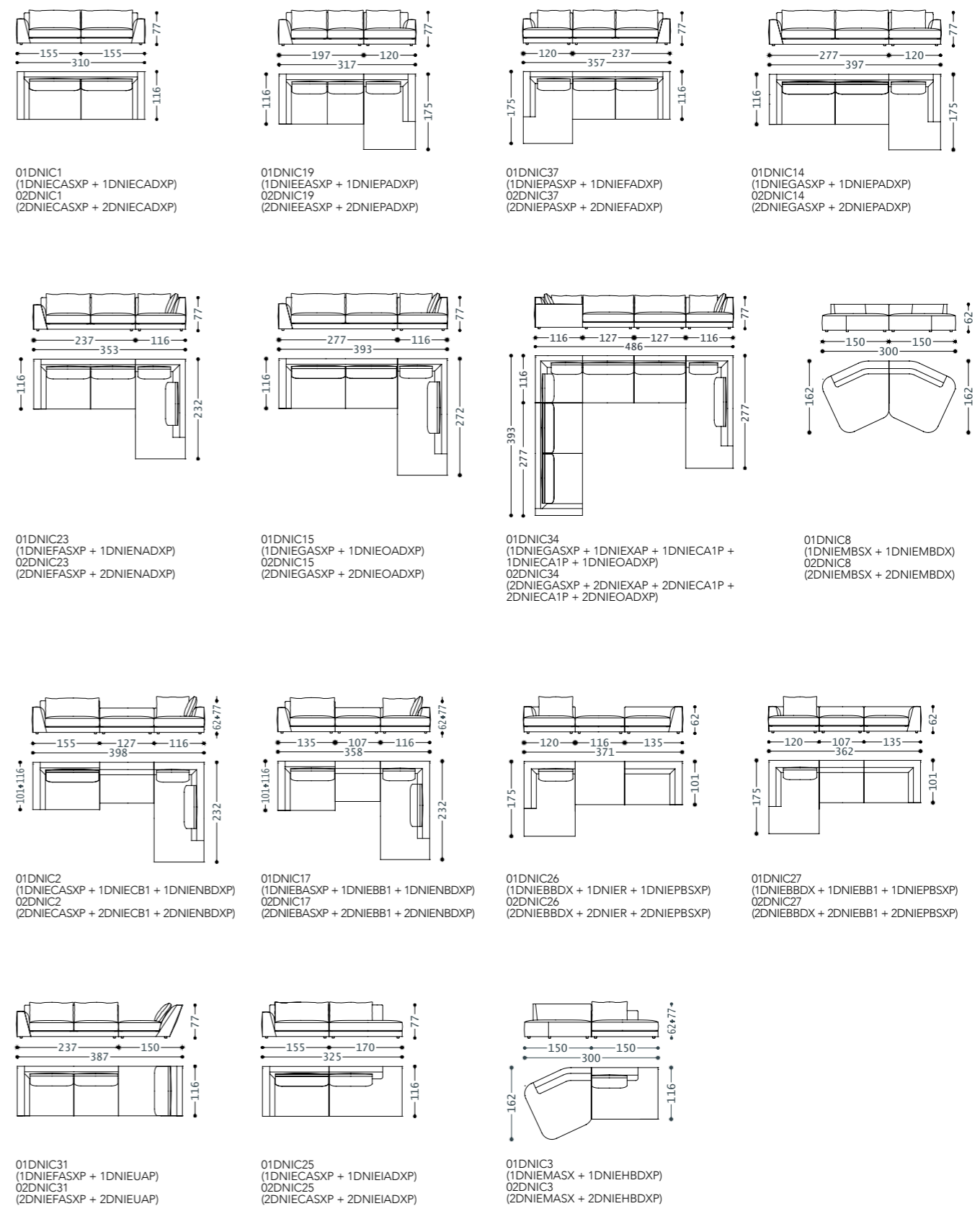
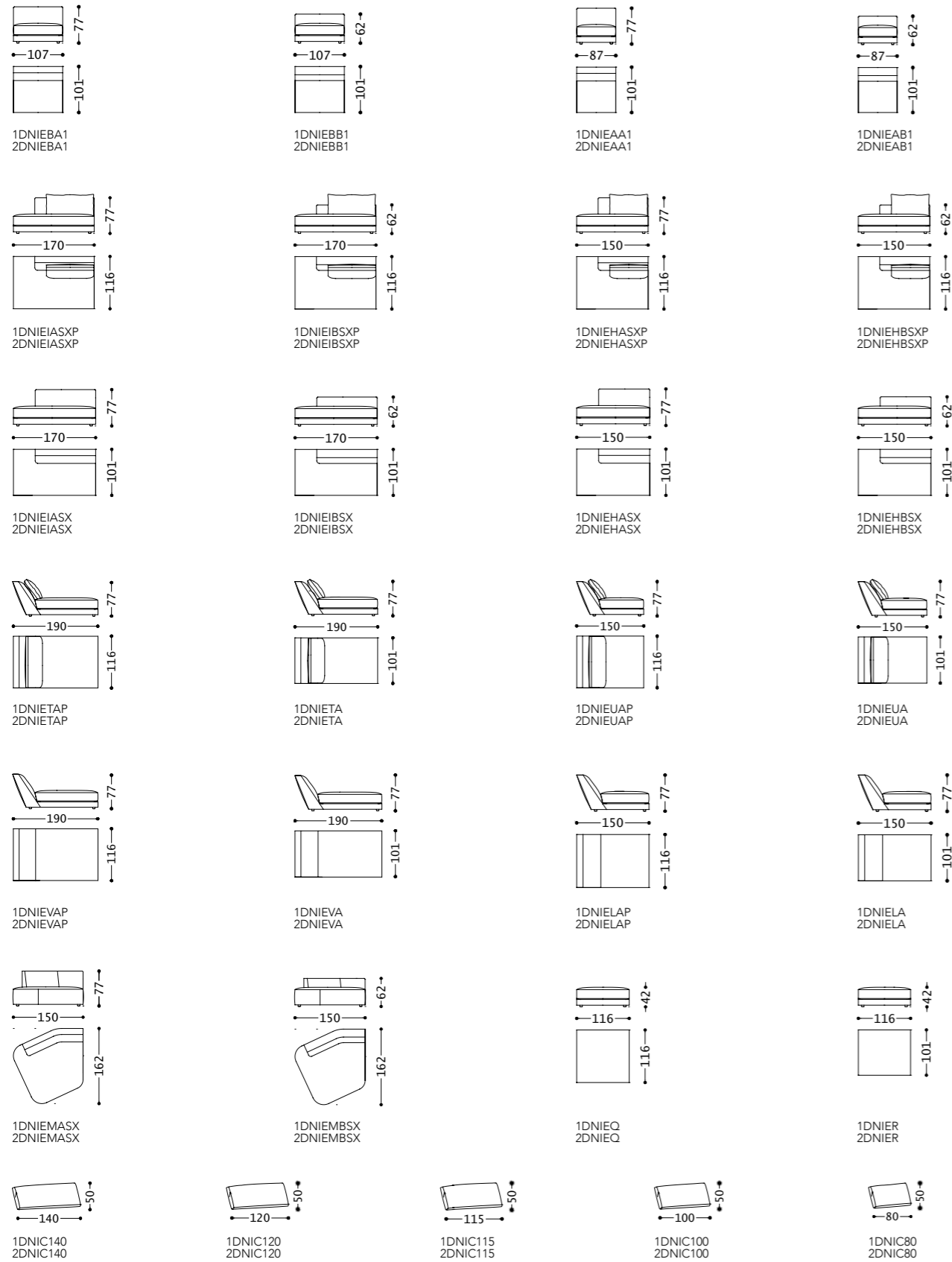

BOWIE divano/sofa/canapé/sofa
 elementi/elements/éléments/elemente

Design by Castello Lagravinese Studio



Struttura portante: Multistrato, massello di legno.
Imbottiture: Schienale in piuma d'oca. Seduta in piuma d'oca con inserto in poliuretano espanso (densità 30 Kg/mc). Scocca e bracciolo in piuma d'oca con inserto in poliuretano espanso a densità differenziata.
Molle: Cinghie elastiche in polipropilene e gomma.
Piedini: In metallo.

Main structure: Multilayer and solid wood.
Upholstery: Backrest in goose feathers. Seat in goose feathers with internal padding in polyurethane foam (density 30 Kg/mc). Chassis and armrest in goose feathers with internal padding in polyurethane foam with different densities.
Suspensions: Elastic belts in polypropylene and rubber.
Feet: In metal.

Structure: Multiplis et bois massif.
Rembourrage: Dossier en plume d'oie. Assise en plume d'oie avec insert en mousse de polyuréthane (densité 30 Kg/mc). Chassis et accoudoir en plume d'oie avec insert en mousse de polyuréthane avec plusieurs densités.
Suspension: Sangles élastiques en polypropylène et mousse.
Pied: En métal.

Struktur: Vielschichtiges Massivholz.
Polsterung: Rückenlehne aus Gänsedaunen. Sitz aus Gänsedaunen mit Einsatz aus Polyurethanschaum (Dichte 30 Kg/mc). Chassis und Armlehne aus Gänsedaunen mit Einsatz aus Polyurethanschaum in unterschiedlichen Dichten.
Federung: Elastische Gurte aus Gummi und Polypropylen.
Füße: Aus Metall.

Cod. Tessuto/fabric/tissu/Stoff: 1/01
 Cod. Pelle/leather/cuir/Leder: 2/02

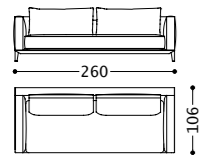
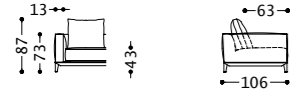

1BOW230
2BOW230

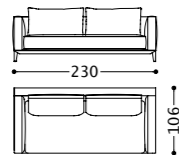

1BOW220
2BOW220

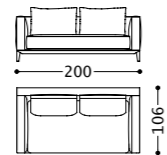

1BOW210
2BOW210

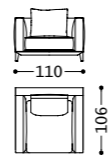

1BOW310
2BOW310

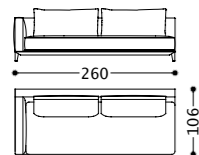

1BOW230SX
2BOW230SX

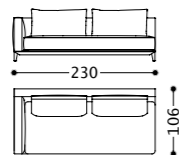

1BOW220SX
2BOW220SX

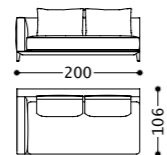

1BOW210SX
2BOW210SX

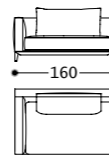

1BOW200SX
2BOW200SX

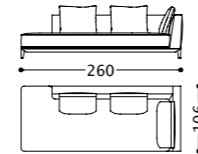

1BOW270SX
2BOW270SX

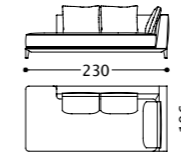

1BOW260SX
2BOW260SX

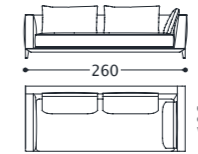

1BOW271SX
2BOW271SX



1BOW261SX
2BOW261SX

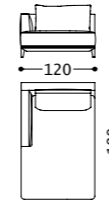

1BOW281SX
2BOW281SX

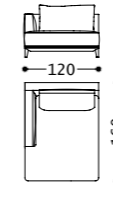

1BOW280SX
2BOW280SX

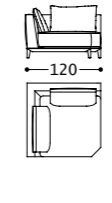

1BOW300
2BOW300

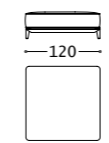

1BOW290
2BOW290

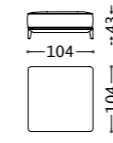

1BOW291
2BOW291

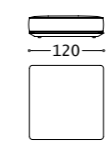

1BOW191
2BOW191

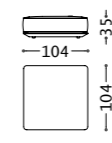

1BOW192
2BOW192

BOWIE divano/sofa/canapé/sofa

composizioni/compositions/compositions/Kompositionen

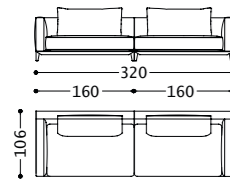

01BOWC4
(1BOW200SX + 1BOW200DX)
02BOWC4
(2BOW200SX + 2BOW200DX)

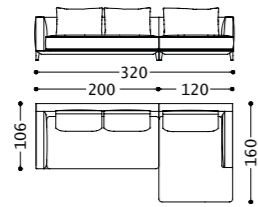

01BOWC3
(1BOW210SX + 1BOW280DX)
02BOWC3
(2BOW210SX + 2BOW280DX)

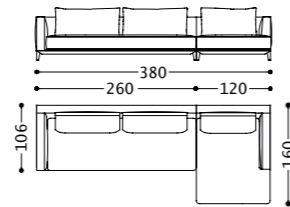

01BOWC6
(1BOW230SX + 1BOW280DX)
02BOWC6
(2BOW230SX + 2BOW280DX)

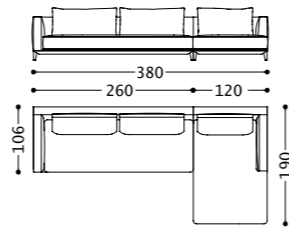

01BOWC10
(1BOW230SX + 1BOW281DX)
02BOWC10
(2BOW230SX + 2BOW281DX)

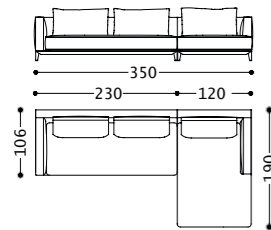

01BOWC8
(1BOW220SX + 1BOW281DX)
02BOWC8
(2BOW220SX + 2BOW281DX)

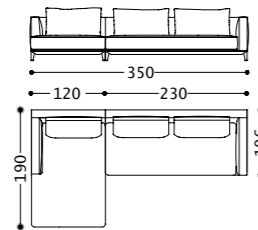

01BOWC15
(1BOW281SX + 1BOW220DX)
02BOWC15
(2BOW281SX + 2BOW220DX)

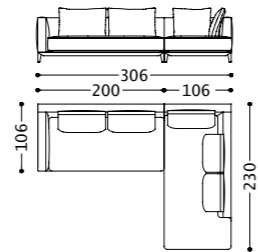

01BOWC2
(1BOW210SX + 1BOW260DX)
02BOWC2
(2BOW210SX + 2BOW260DX)

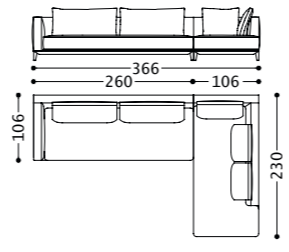

01BOWC11
(1BOW230SX + 1BOW260DX)
02BOWC11
(2BOW230SX + 2BOW260DX)

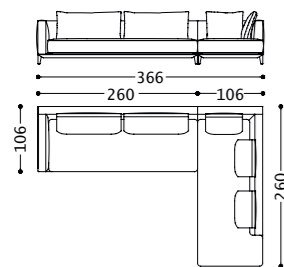

01BOWC1
(1BOW230SX + 1BOW270DX)
02BOWC1
(2BOW230SX + 2BOW270DX)

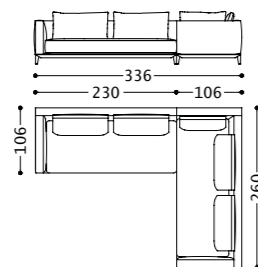

01BOWC5
(1BOW220SX + 1BOW271DX)
02BOWC5
(2BOW220SX + 2BOW271DX)

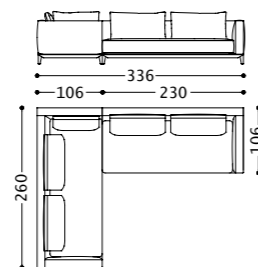

01BOWC14
(1BOW271SX + 1BOW220DX)
02BOWC14
(2BOW271SX + 2BOW220DX)

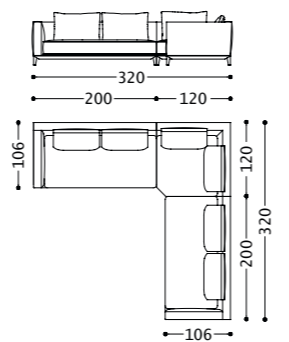

01BOWC9
(1BOW210SX + 1BOW300 + 1BOW210DX)
02BOWC9
(2BOW210SX + 2BOW300 + 2BOW210DX)

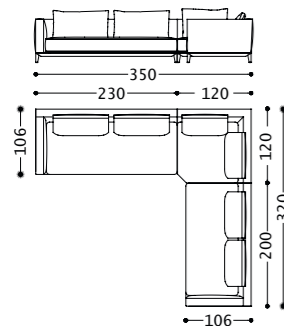

01BOWC7
(1BOW220SX + 1BOW300 + 1BOW210DX)
02BOWC7
(2BOW220SX + 2BOW300 + 2BOW210DX)

GOSSIP poltrona/armchair/fauteuil/Sessel

elementi/elements/éléments/Elemente

Design by Castello Lagravinese Studio



Struttura portante: multistrato, massello di legno.
Imbottiture: Schienale e seduta in poliuretano espanso (densità 40 Kg/mc).
Molleggio: cinghie elastiche in polipropilene e gomma.
Piedini: ABS.

Main structure: Multilayer and solid wood.
Upholstery: Backrest and seat in polyurethane foam (density 40 Kg/mc).
Suspensions: elastic belts in polypropylene and rubber.
Feet: ABS.

Structure: Multiplis et bois massif.
Rembourrage: Dossier et assise en mousse de polyuréthane (densité 40 kg/mc).
Federung: sangles élastiques en polypropylène et mousse.
FüÙe: ABS.

Struktur: vielschichtiges Massivholz.
Polsterung: Rückenlehne und Sitz aus Polyurethanschaum (Dichte 40 Kg/mc).
Federung: elastische Gurte aus Gummi und Polypropylen.
FüÙe: ABS.

Cod. Tessuto/fabric/tissu/Stoff: 1
Cod. Pelle/leather/cuir/Leder: 2

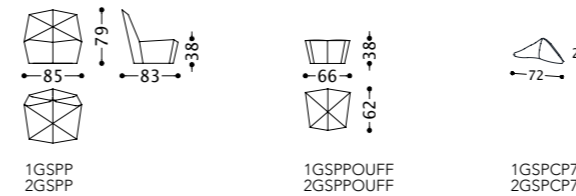

1GSPP
2GSPP

1GSPPPUFF
2GSPPPUFF

1GSPCP72
2GSPCP72

GOSSIP poltrona/armchair/fauteuil/Sessel

composizioni/compositions/Kompositionen

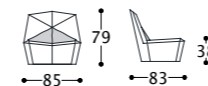

01GSPC1
(1GSPP + 1GSPCP72)
02GSPC1
(2GSPP + 2GSPCP72)

JAMMIN poltrona/armchair/fauteuil/Sessel

elementi/elements/éléments/Elemente

Design by Castello Lagravinese Studio



Struttura portante: multistrato, massello di legno.
Imbottiture: Schienale in poliuretano espanso (densità 21 Kg/mc). Seduta in piuma d'oca con inserto in poliuretano espanso (densità 40 Kg/mc).
Versione fissa: piede in metallo.
Versione girevole: basamento in metallo.

Main structure: Multilayer and solid wood.
Upholstery: Backrest in polyurethane foam (density 21 Kg/mc). Seat in goose feathers with internal padding in polyurethane foam (density 40 Kg/mc).
Fix version: metal feet.
Swivel version: metal base.

Structure: Multiplis et bois massif.
Rembourrage: Dossier en mousse de polyuréthane (densité 21 kg/mc). Assise en plume d'oie avec insert en mousse de polyuréthane (densité 40 kg/mc).
Version fixe: pied en métal.
Version tournante: piétement en métal.

Struktur: vielschichtiges Massivholz.
Polsterung: Rückenlehne aus Polyurethanschaum (Dichte 21 Kg/mc). Sitz aus Gänsedaunen mit Einsatz aus Polyurethanschaum (Dichte 40 Kg/mc).
Fest-Version: Fuß aus Metal.
Dreh-Version: Drehbasis aus Metall.

Cod. Tessuto/fabric/tissu/Stoff: 1
 Cod. Pelle/leather/cuir/Leder: 2

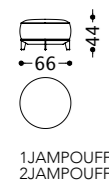
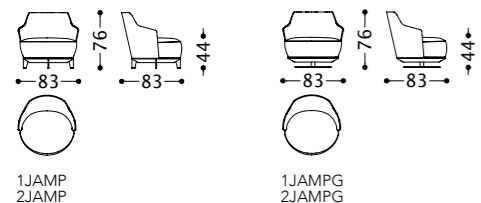

JAMMIN LARGE poltrona/armchair/fauteuil/Sessel

elementi/elements/éléments/Elemente

Design by Castello Lagravinese Studio



Struttura portante: multistrato, massello di legno.
Imbottiture: Schienale in poliuretano espanso (densità 21 Kg/mc). Seduta in piuma d'oca con inserto in poliuretano espanso (densità 40 Kg/mc).
Versione fissa: piede in metallo.
Versione girevole: basamento in metallo.

Main structure: Multilayer and solid wood.
Upholstery: Backrest in polyurethane foam (density 21 Kg/mc). Seat in goose feathers with internal padding in polyurethane foam (density 40 Kg/mc).
Fix version: metal feet.
Swivel version: metal base.

Structure: Multiplis et bois massif.
Rembourrage: Dossier en mousse de polyuréthane (densité 21 kg/mc). Assise en plume d'oie avec insert en mousse de polyuréthane (densité 40 kg/mc).
Version fixe: pied en métal.
Version tournante: piétement en métal.

Struktur: vielschichtiges Massivholz.
Polsterung: Rückenlehne aus Polyurethanschaum (Dichte 21 Kg/mc). Sitz aus Gänsedaunen mit Einsatz aus Polyurethanschaum (Dichte 40 Kg/mc).
Fest-Version: Fuß aus Metal.
Dreh-Version: Drehbasis aus Metall.

Cod. Tessuto/fabric/tissu/Stoff: 1
 Cod. Pelle/leather/cuir/Leder: 2

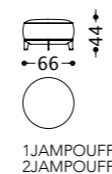
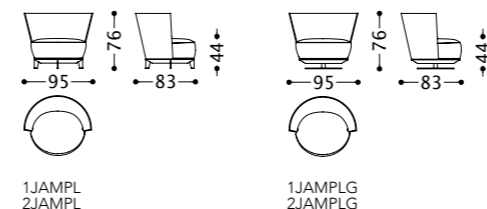

SWEET JANE poltrona/armchair/fauteuil/Sessel

elementi/elements/éléments/Elemente

Design by Maurizio Manzoni - Studio Memo Firenze



Struttura portante: multistrato, massello di legno.
Struttura cuscino schienale: in metallo.
Imbottiture: schienale e seduta in poliuretano espanso a densità differenziata.
Molleggio: cinghie elastiche in polipropilene e gomma.
Gambe: in metallo.

Main structure: multilayer and solid wood.
Back cushion structure: in metal.
Upholstery: backrest and seat in polyurethane foam with different densities.
Suspensions: elastic belts in polypropylene and rubber.
Legs: in metal.

Structure: multiplis et bois massif.
Structure coussin de dossier: en métal.
Rembourrage: dossier et assise en mousse de polyuréthane en plusieurs densités.
Suspension: Sangles élastiques en polypropylène et mousse.
Jambes: en métal.

Struktur: vielschichtiges Massivholz.
Rückenkissenstruktur: aus Metall.
Polsterung: Rückenlehne und Sitz aus Polyurethanschaum in unterschiedlichen Dichte.
Federung: elastische Gurte aus Gummi und Polypropylen.
Beine: aus Metall.

Cod. Tessuto/fabric/tissu/Stoff: 1
Cod. Pelle/leather/cuir/Leder: 2

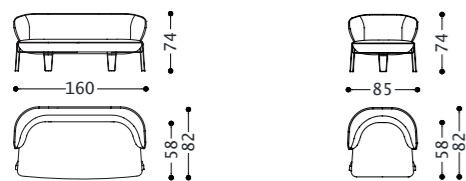
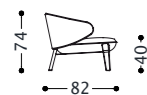

1SWJD2
2SWJD2

1SWJP
2SWJP

CECILE poltrona/armchair/fauteuil/Sessel

elementi/elements/éléments/Elemente

Design by Studio Memo Firenze



Struttura cuscino schiena: Pannello in multistrato.
Struttura portante: Legno/Metallo.
Imbottiture: Cuscino di schienale in piuma d'oca e fibra di poliestere con inserto in poliuretano espanso (densità 25 kg/mc) rivestito in tela di cotone. Cuscino di seduta in poliuretano espanso (densità 35 kg/mc), piuma d'oca e fibra di poliestere rivestito in tela di cotone.
Molleggio: Cinghie elastiche in polipropilene e gomma.

Back cushion structure: Multilayer panel.
Main structure: Wood/Metal.
Upholstery: Backrest in goose feathers and polyester fiber with internal padding in polyurethane foam (density 25 kg/mc) covered with cotton fabric. Seat cushion in polyurethane foam (density 35 kg/mc), goose feathers and polyester fiber, covered with cotton fabric.
Suspensions: Elastic belts in polypropylene and rubber.

Structure coussin de dossier: Panneau multiplis.
Structure: Bois/ Métal.
Rembourrage: Coussin de dossier en plumes d'oie et fibre de polyester avec insert en mousse de polyuréthane (densité 25 Kg/mc) sous housse de coton. Coussin d'assise en mousse de polyuréthane (densité 35 Kg/mc), plumes d'oie et fibre de polyester sous housse de coton.
Suspension: Sangles élastiques en polypropylène et mousse.

Rückenkissenstruktur: Schichtholz-Paneel.
Hauptstruktur: Holz/Metall.
Polsterung: Rückenkissen aus Gänsedaunen und Polyesterfaser mit Einsatz aus Polyurethanschaum (Dichte 25 kg/mc) mit Baumwoll bezug verkleidet. Sitz aus Polyurethanschaum (Dichte 35 kg/mc), Gänsedaunen und Polyesterfaser mit Baumwoll bezug verkleidet.
Federung: Elastische Gurte aus Gummi und Polypropylen.

Cod. Tessuto/fabric/tissu/Stoff: 1
Cod. Pelle/leather/cuir/Leder: 2

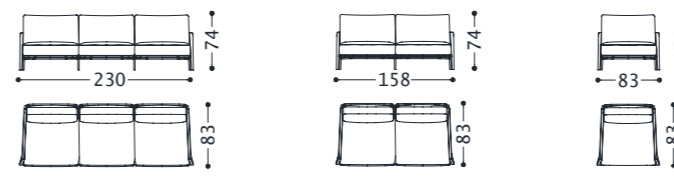

1CECD3NC
2CECD3NC

1CECD3W
2CECD3W

1CECD2NC
2CECD2NC

1CECD2W
2CECD2W

1CECPNC
2CECPNC

1CECPW
2CECPW

ISLAND tavolino/small table/table/Couchtisch
elementi/elements/éléments/Elemente

Design by Castello Lagravinese Studio



Struttura: Metallo.
Top: MDF impiallacciato.

Structure: Metal.
Top: Veneer MDF.

Structure: Métal.
Plateau: MDF placage.

Struktur: Metall.
Top: Furniert MDF.

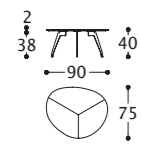

1ISNTSTS40

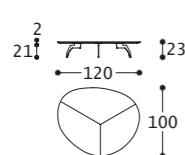

1ISNTMTS23

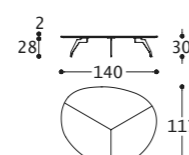

1ISNTLTS30

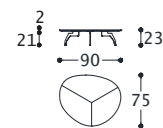

1ISNTST23

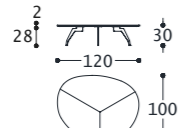

1ISNTMT30

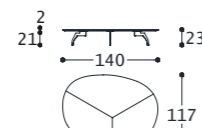

1ISNTLT23

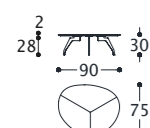

1ISNTST30

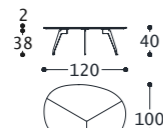

1ISNTMT40

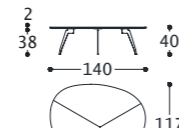

1ISNTLT40

JIMMY 3 tavolino/small table/table/Couchtisch
elementi/elements/éléments/Elemente

Design by Castello Lagravinese Studio



Struttura: metallica.
Top: MDF (laccato).

Structure: in metal.
Top: MDF (lacquered).

Structure: en métal.
Plateau: MDF (laqué).

Struktur: aus Metall.
Niedriger: MDF (lackiert).

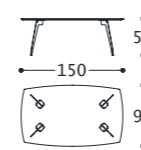

1JI3TAVRH

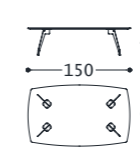

1JI3TAVRM

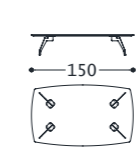

1JI3TAVRL

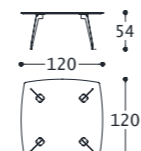

1JI3TAVQ120H

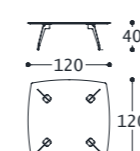

1JI3TAVQ120M

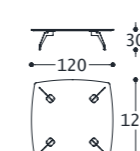

1JI3TAVQ120L

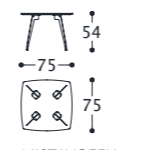

1JI3TAVQ75H

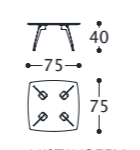

1JI3TAVQ75M

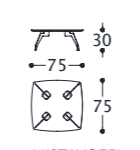

1JI3TAVQ75L



1JI3TAVQ55H



1JI3TAVQ55M



1JI3TAVQ55L

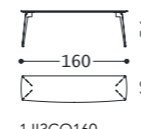

1JI3CO160

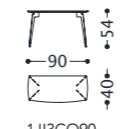

1JI3CO90

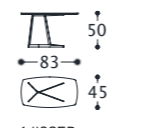

1JI3SER

JAGGER tavolino/small table/table/Couchtisch
elementi/elements/éléments/Elemente

Design by Castello Lagravinese Studio



Struttura: metallica a 5 gambe.
Finitura struttura: laccato.
Top: MDF.
Finitura top: laccato.

Structure: in metal with 5 legs.
Structure finishing: lacquered.
Top: MDF.
Top finishing: lacquered.

Structure: en métal avec 5 jambes.
Finition de la structure: laqué.
Plateau: MDF.
Finition du plateau: laqué.

Struktur: aus Metall mit 5 Beine.
Strukturbearbeitung: lackiert.
Top: MDF.
Topbearbeitung: lackiert.



1JAGTH



1JAGTL



1JAGTM

PHIL tavolino/small table/table/Couchtisch
elementi/elements/éléments/Elemente

Design by Castello Lagravinese Studio



Struttura: metallica.
Top: in marmo o MDF (laccato).

Structure: in metal.
Top: marble or MDF (laquered).

Structure: en métal.
Plateau: marbre ou MDF (laqué).

Struktur: aus Metall.
Top: Marmor oder MDF (lackiert).

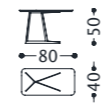

1PHISER
1PHISERL

FRISCO tavolino/small table/table/Couchtisch
 elementi/elements/éléments/Elemente

Design by Castello Lagravinese Studio



Struttura: metallica.
Top alto (1): marmo o MDF (laccato).
Top basso (2): MDF (laccato).

Structure: in metal.
Top high (1): marble or MDF (lacquered).
Top low (2): MDF (lacquered).

Structure: en métal.
Plateau haut (1): marbre ou MDF (laqué).
Plateau bas (2): MDF (laqué).

Struktur: aus Metall.
Hoher Top (1): Marmor oder MDF (lackiert).
Niedriger Top (2): MDF (lackiert).



1FRITROT
1FRITROTL

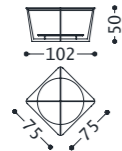

1FRITAVQA
1FRITAVQAL

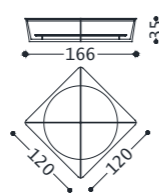

1FRITAVQB
1FRITAVQBL

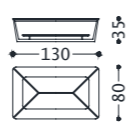

1FRITAVR
1FRITAVRL

ALBERT 1 tavolino/small table/table/Couchtisch
 elementi/elements/éléments/Elemente

Design by Castello Lagravinese Studio



Struttura: Legno massello.
Top: Marmo

Structure: Solid wood.
Top: Marble

Structure: Bois massif.
Plateau: Marbre

Struktur: Massivholz.
Top: Marmor

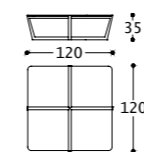

1AL1TAVQ

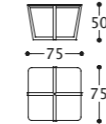

1AL1TAVQ75

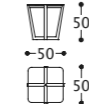

1AL1TAVQ50

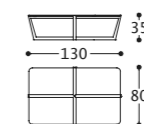

1AL1TAVR

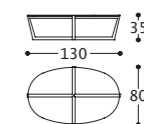

1AL1TAVOV

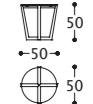

1AL1TROT50



Maurizio Manzoni - Studio Memo Firenze for:
SWEET JANE armchair
Studio Memo Firenze for:
CECILE armchair
Castello Lagravinese Studio for:
BOWIE - DION - LAGUNA sofas
GOSSIP - JAMMIN - JAMMIN LARGE armchairs
ALBERT 1 - FRISCO - ISLAND - JAGGER - JIMMY 3 - PHIL tables



Photography
Davide Cerati
Emozioni.com
Rendering
Eido
Styling
Sissi Valassina
Luigina Pilloni
Graphic Assistant
Bplus marketing

alberta

via Toniolo 41
31028 Vazzola (TV) - ITALY
T +39 0438 440440
F +39 0438 441555
www.alberta.it